

# TECHNICAL SPECIFICATION

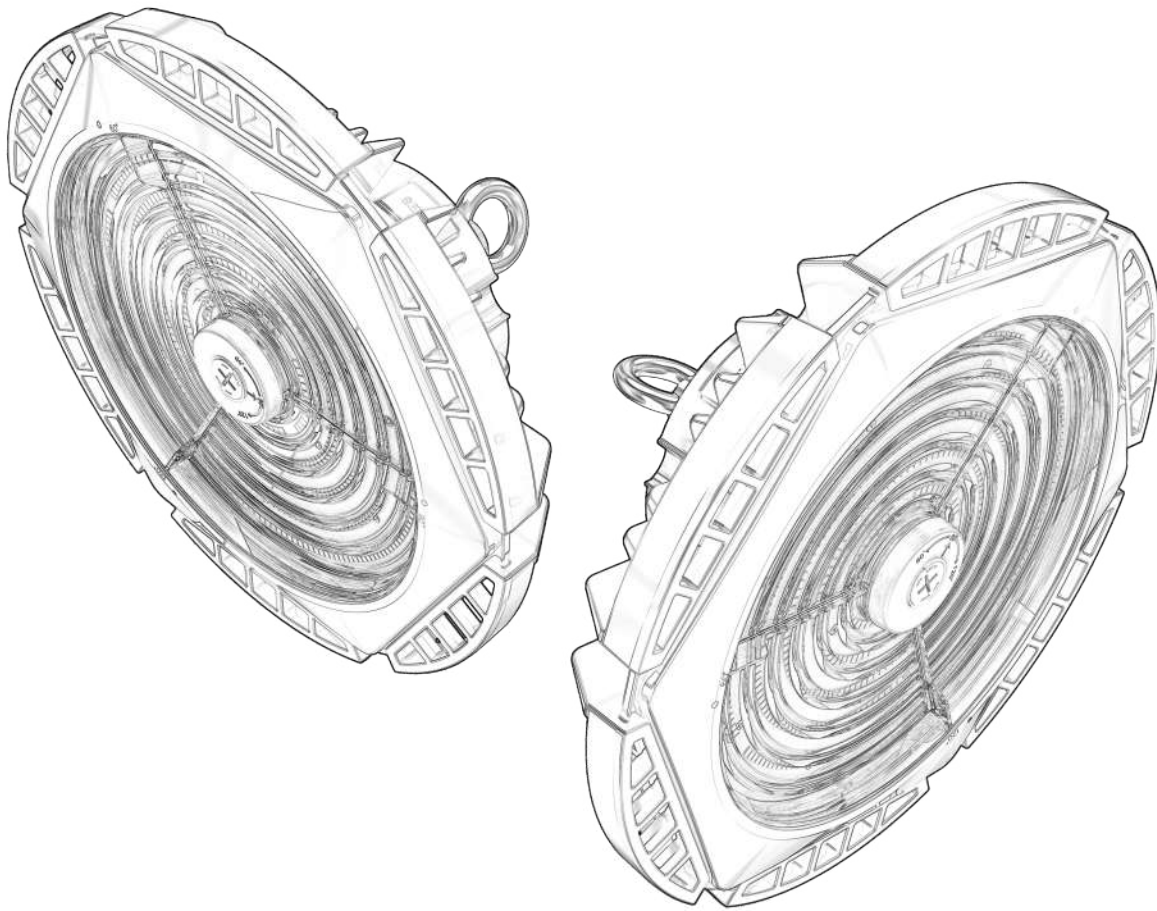

<b>Specification Revision:</b>		
RevA0	Primary Released	Date: 15-Sep-2023
RevA1 or B0	Updated Notes	Date:
Approved By	Verified By	Drafted By
Mike Lee	Lista Lee	Tyler Hou

<b>Model</b>	<b>HB-JL15-SE Energy Saving Version</b>	<b>HB-JL15-EV Economic Version</b>
--------------	---	--



### Electrical Specification

POWER	70-100-120-160W (Power Selectable)	
Driver Brand	CRYSTAL (Options of PHILIPS / MOSO / SOSEN /LIFUD ...)	
Input Voltage	100 ~ 240 VAC (Option of 200 ~ 240 VAC )	
POWER FACTOR	>0.92	
Dimmable	N/A (Options of 0-10V, PWM, DALI)	
SENSOR	N/A (Available in Motion /PIR /Photocell)	
SPD	4KV Line-Line, 6KV Line-Earth	
Working Temperature	-40°C - 70°C	
THD	<20%	

### Photometrical Specification

Luminous Efficacy	Energy Saving Version	160Lm/W (Options of 130 / 140 /150 / 160 Lm/W)
	Economic Version	210 Lm/W (Options of 170 / 180 /200 / 210 Lm/W)
LED CHIP	SANAN (Options of Lumileds / Cree / Epistar)	
Color Temperature	4000K-5000K (CCT Selectable)	
Color Rendering Index	>80 (Option of >70 RA)	
Beam Angle	( 3 IN One Selectable) 60° - 90° - 120°	

### Mechanical Specification

Body Material	Die Cast Aluminium Housing	
Housing Color	Black (Option of Customized Color)	
Mounting Type	Hook Up (Options of Various Brackets)	
Mounting Location	Wall / Ceiling	
Cable Length	300mm (input)	

### Standards & Certificates

Ingress Protection	IP65	
IK	IK08	
Luminaire Type	Class I	
Certificates	CE, ROHS	
Warranty	5 Years (Option of 2 Years / 3 Years)	

### Dimension & Weight

Fixture Dimension (mm)	350*168	350*189
Fixture Weight (kg)	2.6	3.12
Packing	1	
Carton Dimension(mm)	400*400*170	400*400*195
Gross Weight (Kg)	3.7	4.5

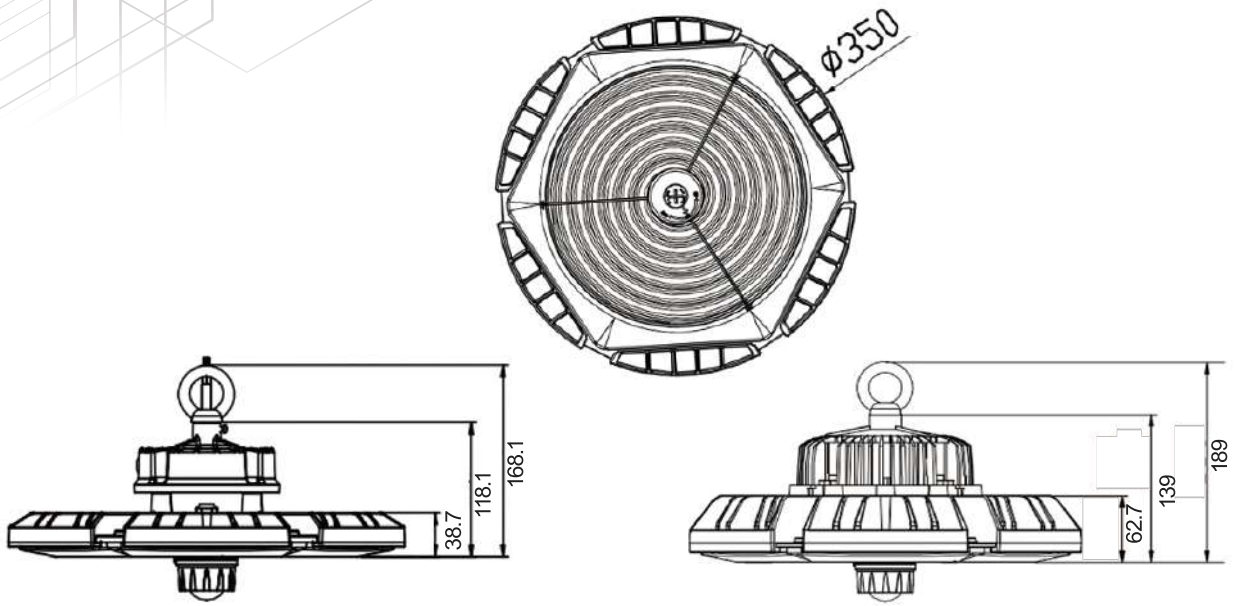

### Structure Diagrams

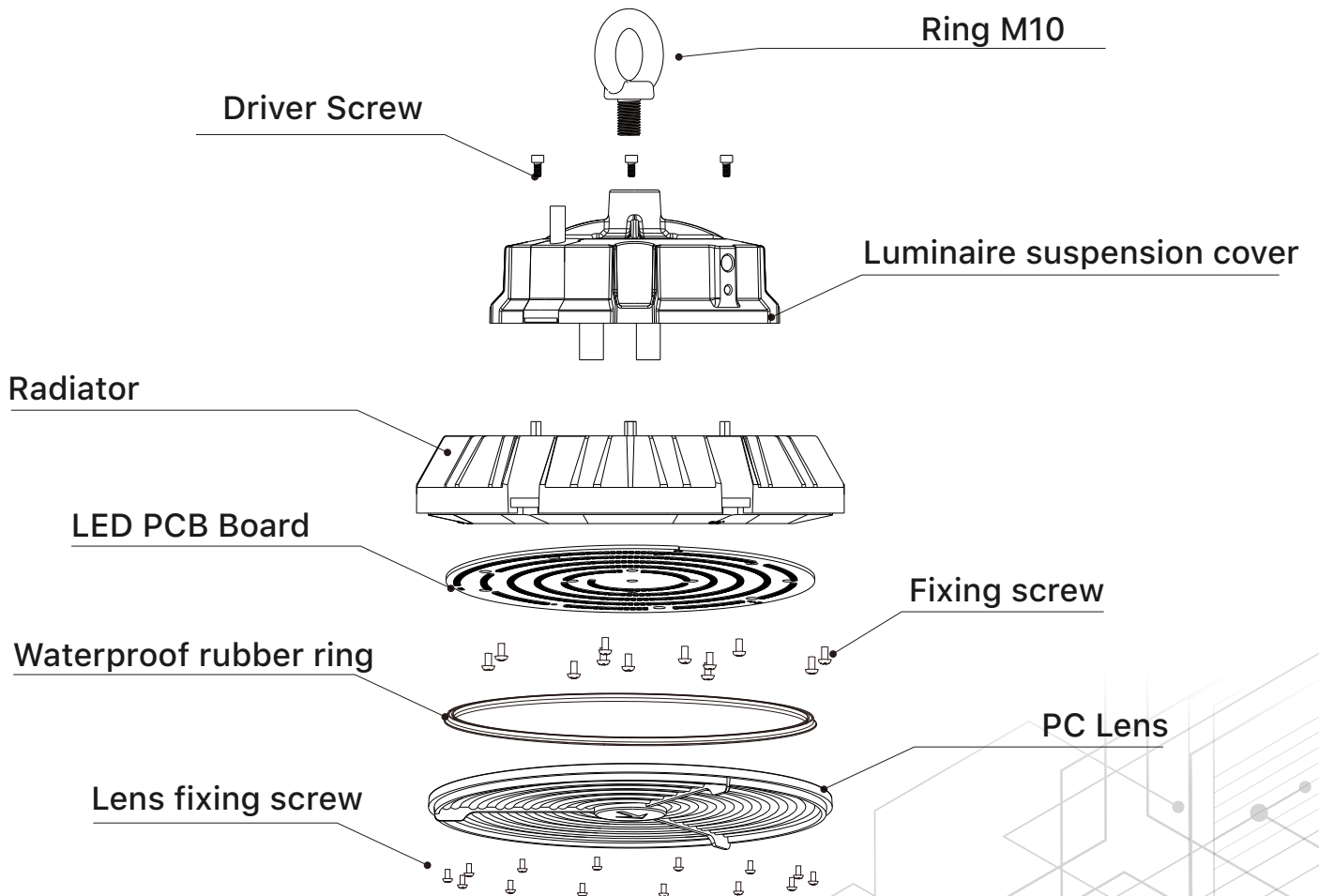

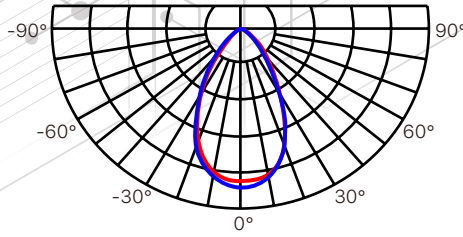

60° Beam Angle

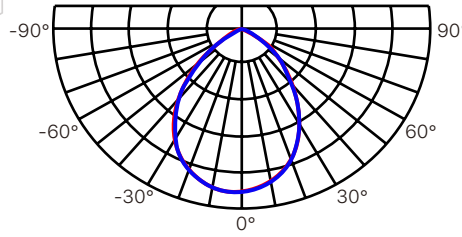

90° Beam Angle

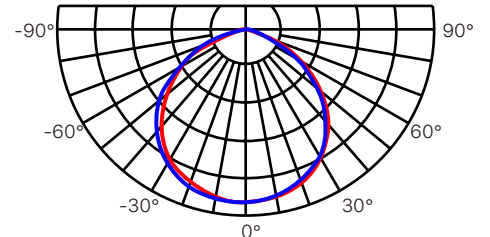

120° Beam Angle

Energy Saving Version 160Lm/W

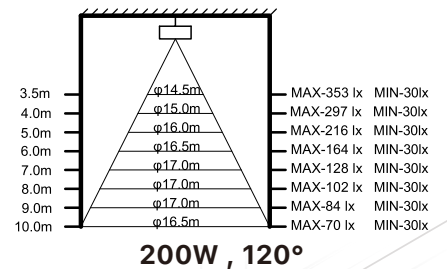
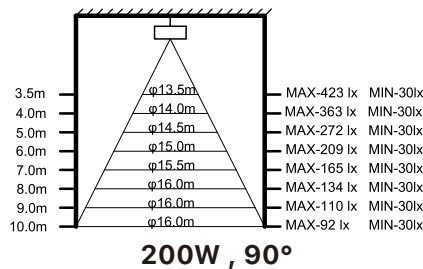
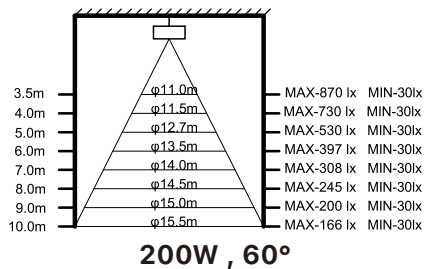
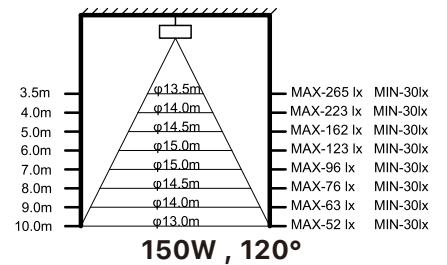
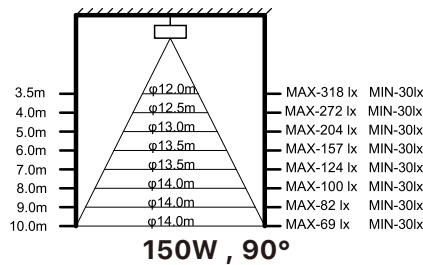
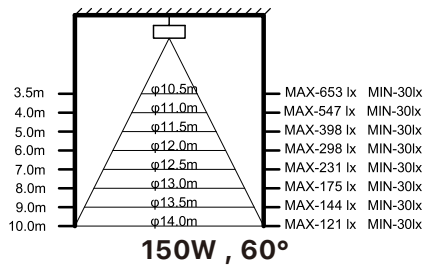
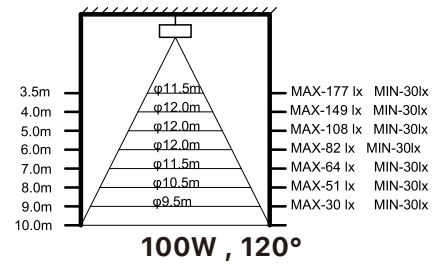
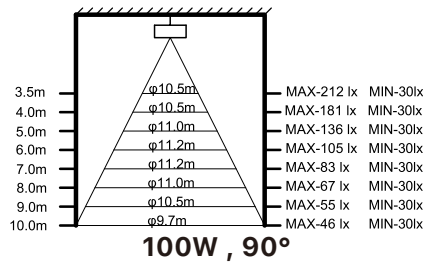
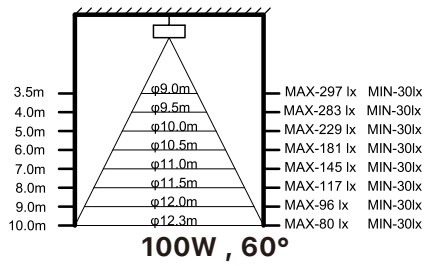

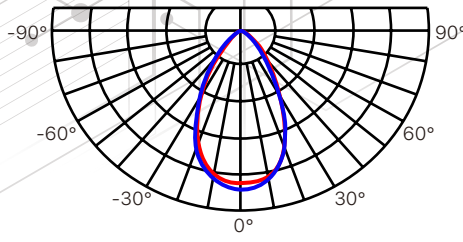

60° Beam Angle

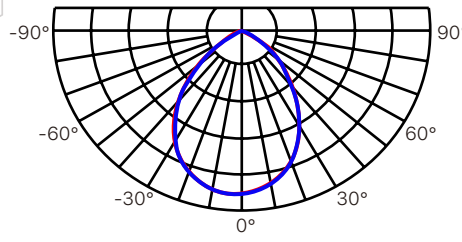

90° Beam Angle

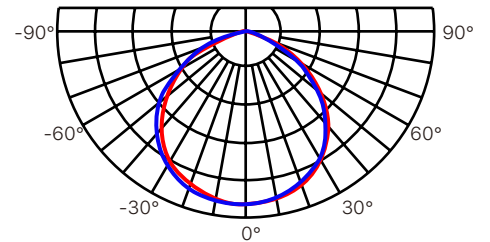

120° Beam Angle

Economic Version 210Lm/W

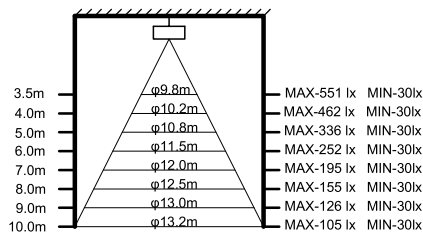

100W , 60°

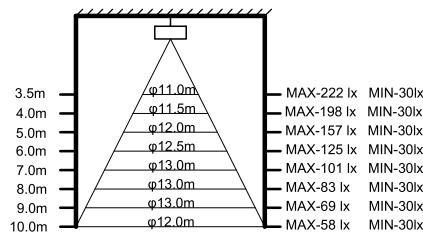

100W , 90°

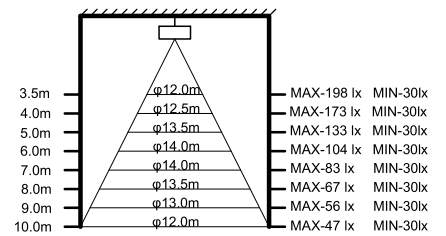

100W , 120°

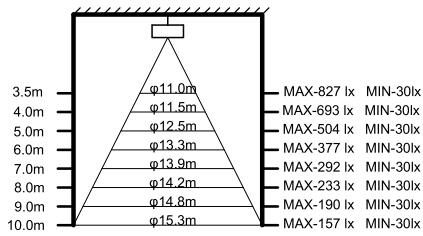

150W , 60°

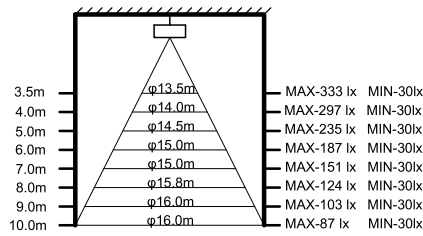

150W , 90°

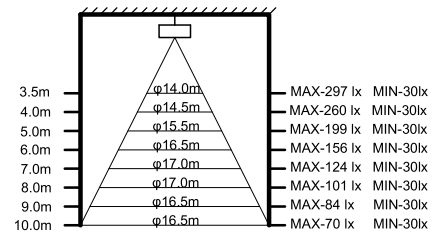

150W , 120°

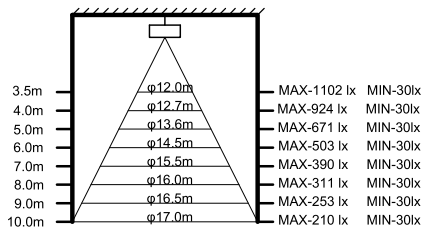

200W , 60°

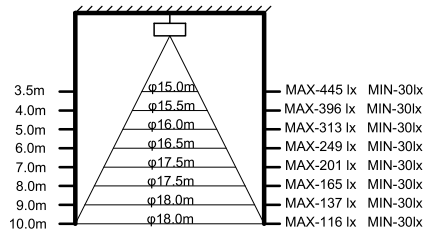

200W , 90°

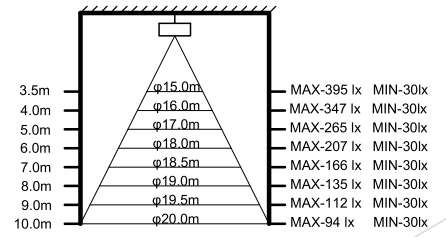

200W , 120°