

TECHNICAL SPECIFICATION

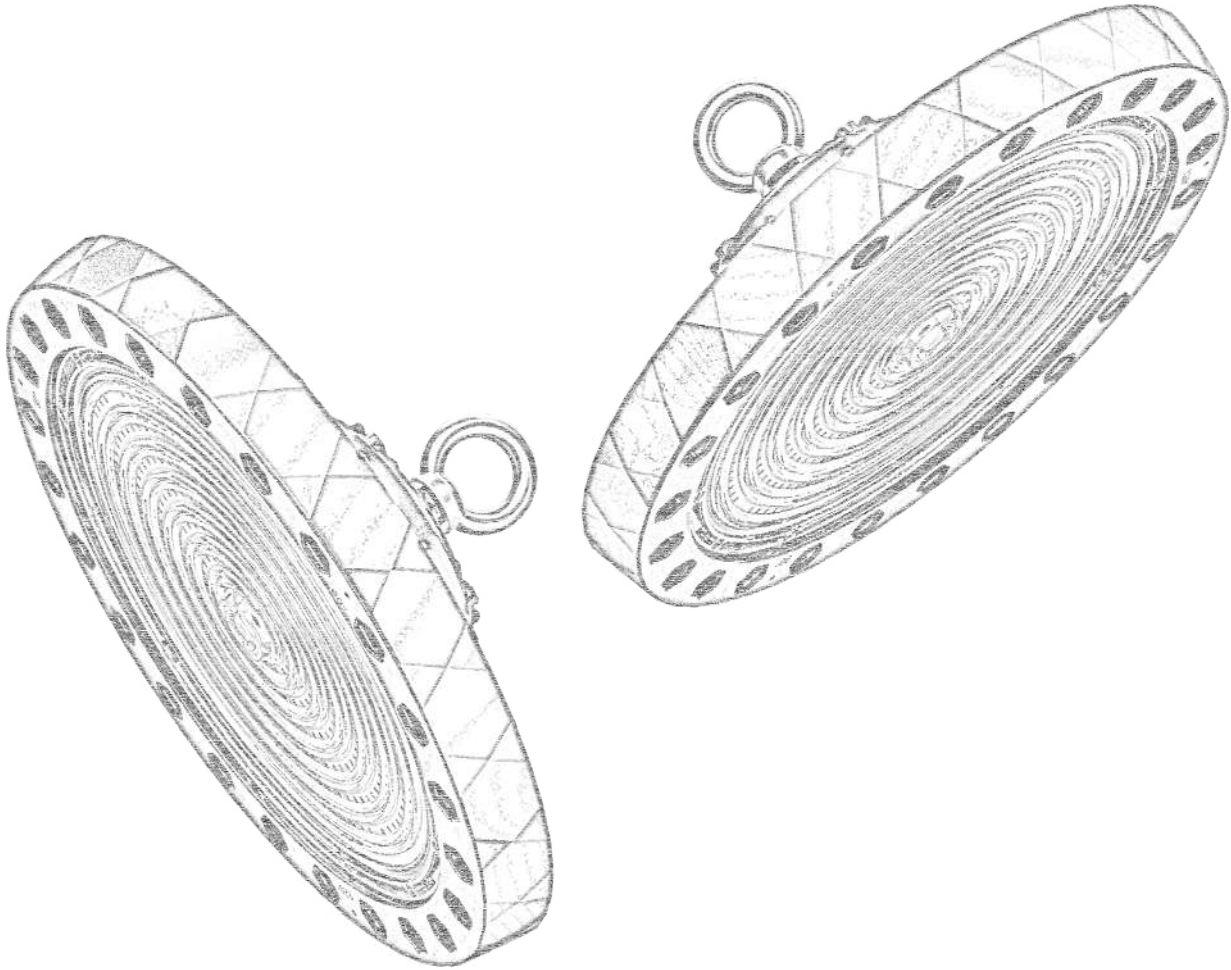

Specification Revision:		
RevA0	Primary Released	Date: 15-Sep-2023
RevA1 or B0	Updated Notes	Date:
Approved By	Verified By	Drafted By
Mike Lee	Lista Lee	Tyler Hou

Model	HB-JL16AL-100W	HB-JL16AL-150W	HB-JL16AL-200W
-------	----------------	----------------	----------------



Electrical Specification

POWER	Basic Version	100W	150W	200W
	Energy Saving Version	80W	120W	160W
Driver Brand	CRYSTAL (Options of PHILIPS / MOSO / SOSEN / LIFUD ...)			
Input Voltage	100 ~ 277 VAC (Option of 200 ~ 240 VAC)			
POWER FACTOR	>0.92			
Dimmable	N/A (Options of 0-10V, PWM, DALI)			
SENSOR	N/A (Available in Motion)			
SPD	4KV Line-Line, 6KV Line-Earth			
Working Temperature	-40°C - 70°C			
THD	<20%			

Photometrical Specification

Luminous Efficacy	Basic Version	150Lm/W (Options of 130 / 140 /150 / 160 Lm/W)
	Energy Saving Version	190 Lm/W (Options of 170 / 180 /200 / 210 Lm/W)
LED CHIP	SANAN (Options of Lumileds / Cree / Epistar)	
Color Temperature	3000K / 4000K / 5000K / 6000K (Or Higher)	
Color Rendering Index	>80 (Option of >70 RA)	
Beam Angle	(3 IN One Selectable) 60° - 90° - 120°	

Mechanical Specification

Body Material	Die Cast Aluminium Housing
Housing Color	Black (Option of Customized Color)
Mounting Type	Hook Up (Options of Various Brackets)
Mounting Location	Wall / Ceiling
Cable Length	350mm (input)

Standards & Certificates

Ingress Protection	IP65
IK	IK08
Luminaire Type	Class I
Certificates	CE, ROHS
Warranty	5 Years (Option of 2 Years / 3 Years)

Dimension & Weight

Fixture Dimension (mm)	249*124	286*126	328*132
Fixture Weight (kg)	1.62	2.2	2.5
Packing	1		
Carton Dimension(mm)	270*270*150	290*290*150	330*330*150
Gross Weight (Kg)	2.12	2.7	3.12

Built-in power model

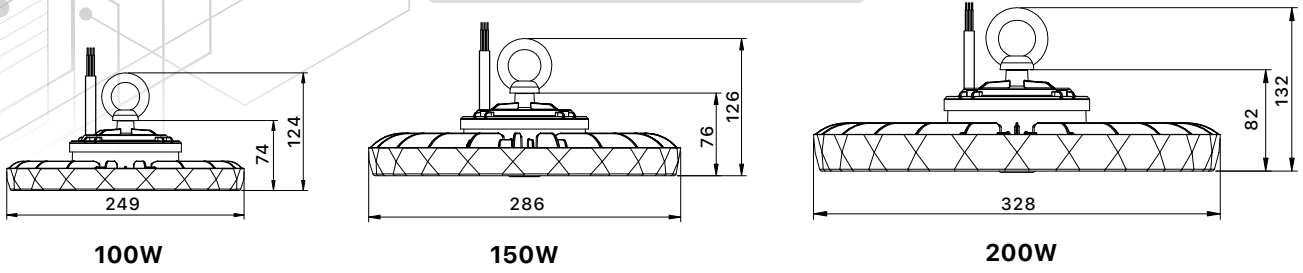

External power supply model

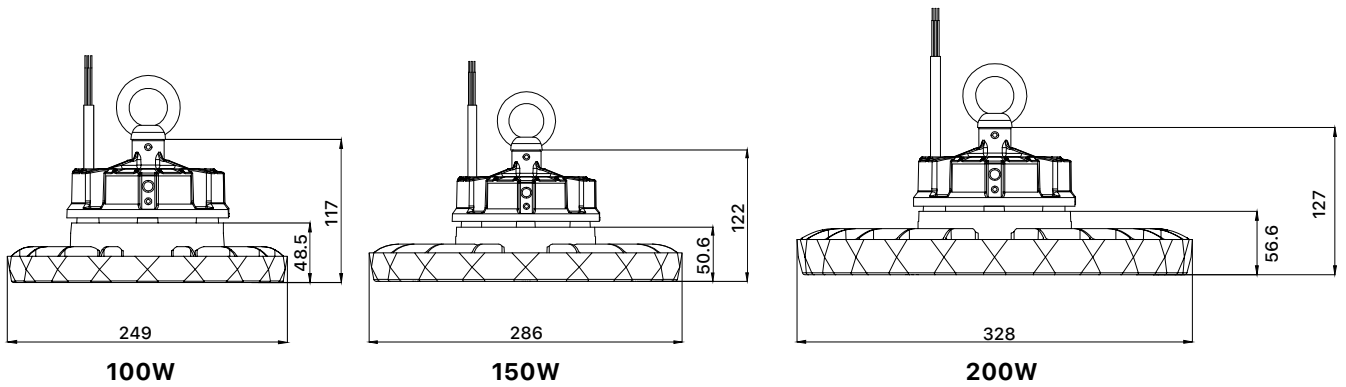

Structure Diagrams

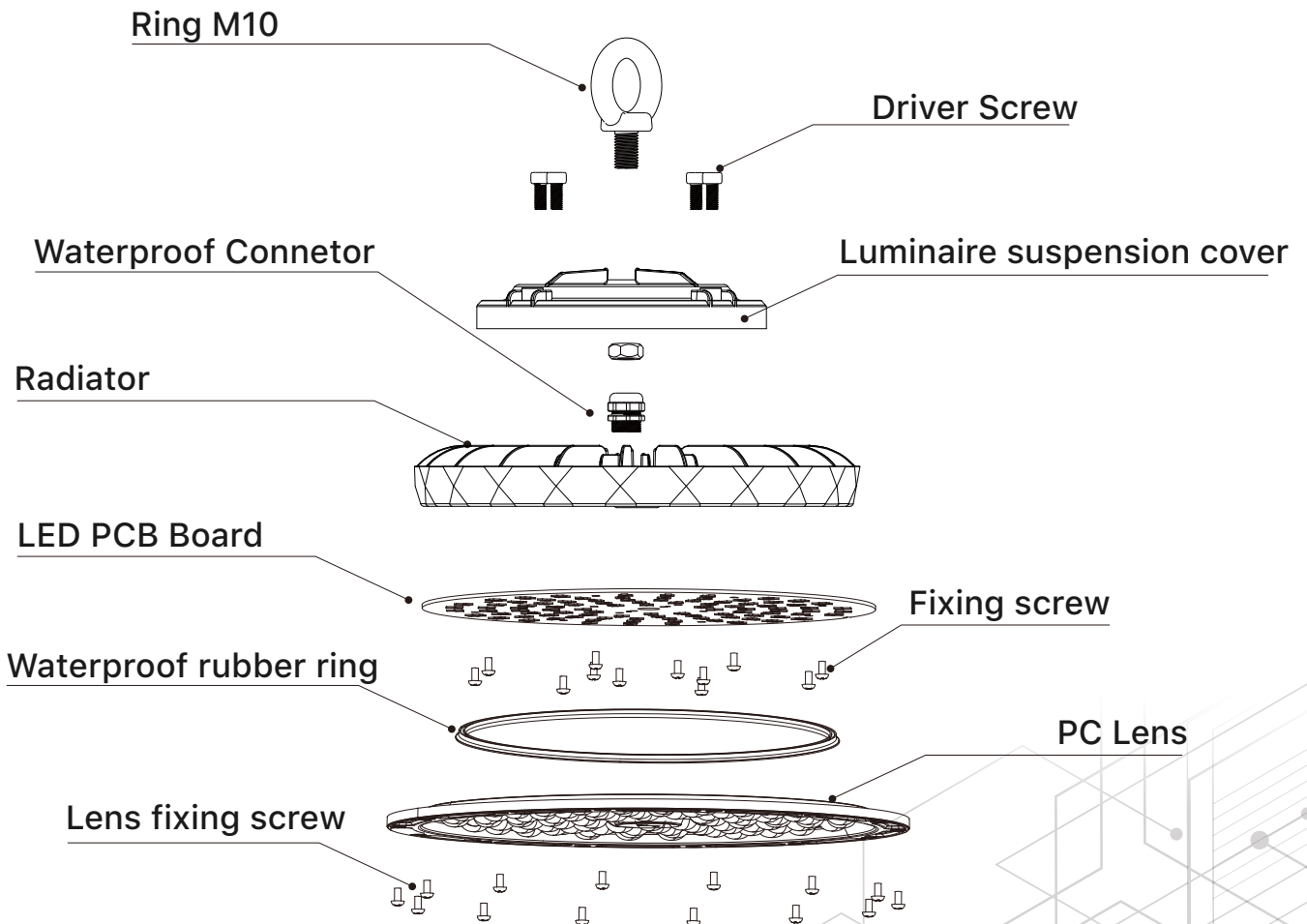

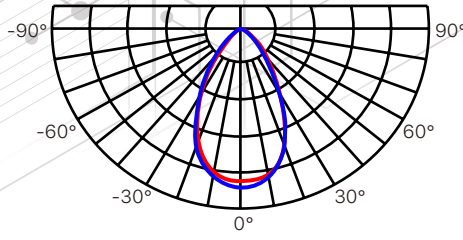

60° Beam Angle

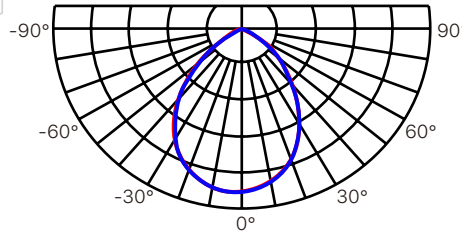

90° Beam Angle

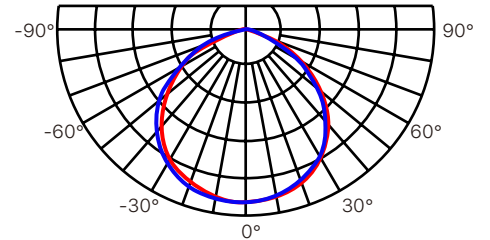

120° Beam Angle

Basic Version 150Lm/W

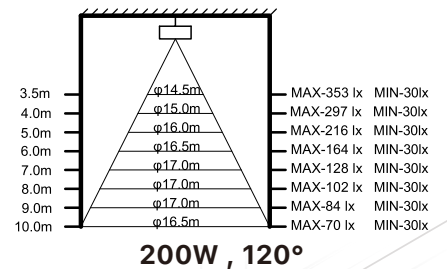
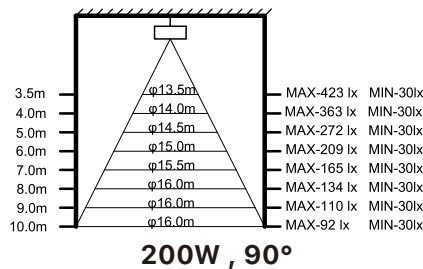
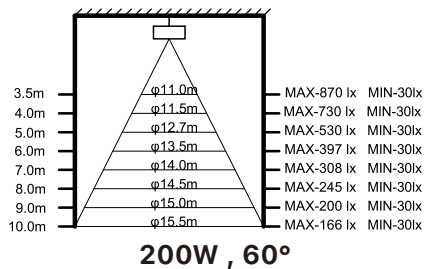
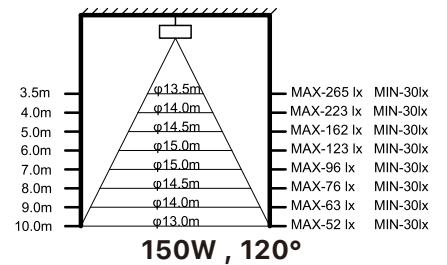
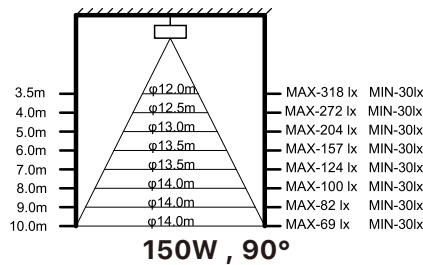
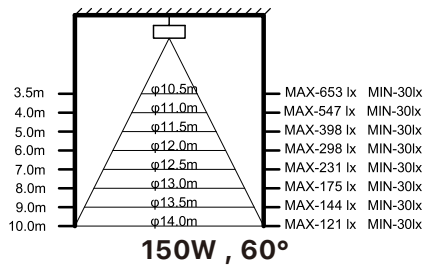
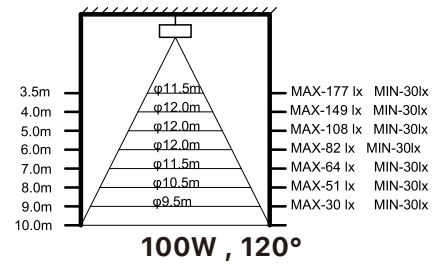
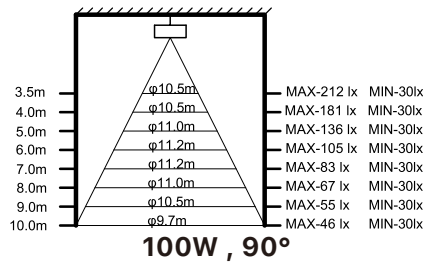
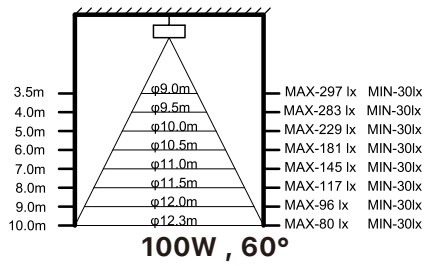

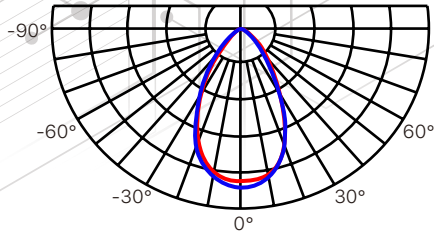

60° Beam Angle

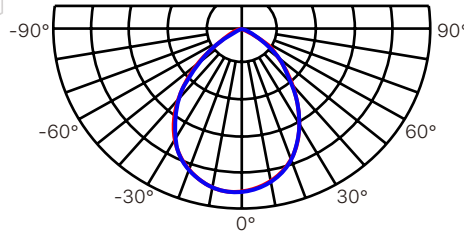

90° Beam Angle

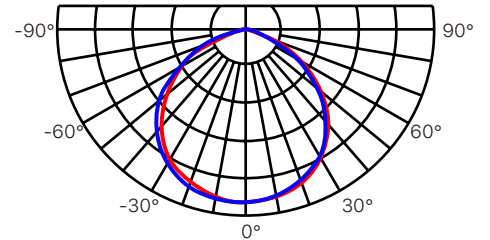

120° Beam Angle

Energy Saving Version 190Lm/W

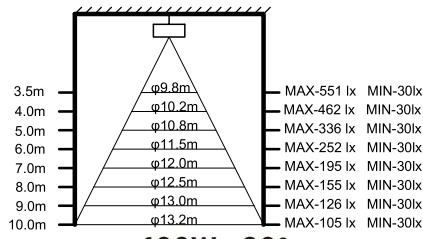

100W , 60°

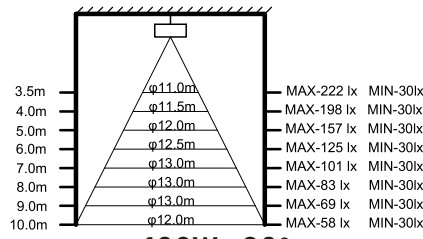

100W , 90°

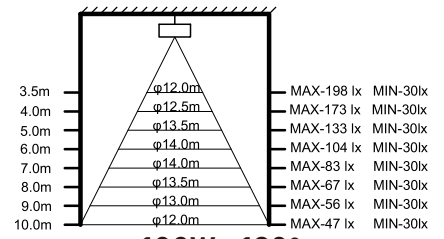

100W , 120°

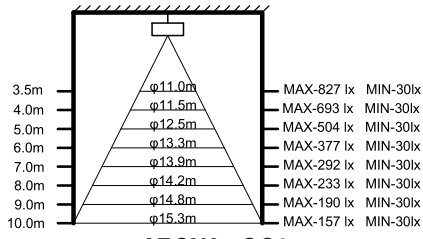

150W , 60°

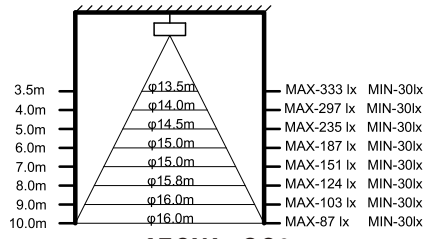

150W , 90°

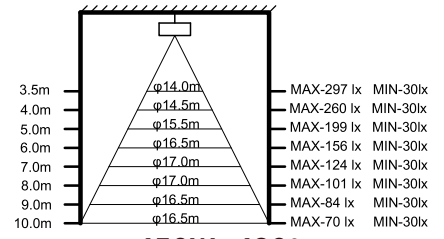

150W , 120°

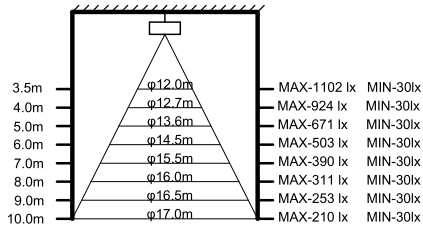

200W , 60°

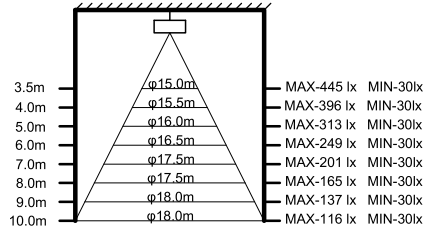

200W , 90°

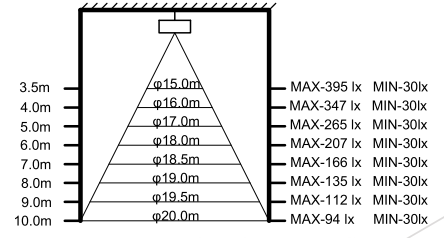

200W , 120°